

NOT FOR
CONSTRUCTION

100 LECKY ROAD PTY LTD BANYAN PLACE ESTATE FLP STAGE 5 70-100 LECKY ROAD, OFFICER CARDINIA SHIRE COUNCIL

SHEET INDEX

1. LOCALITY PLAN, TYPICAL CROSS SECTIONS, SOT & SHEET INDEX
2. DETAIL PLAN
3. TURNING TEMPLATES

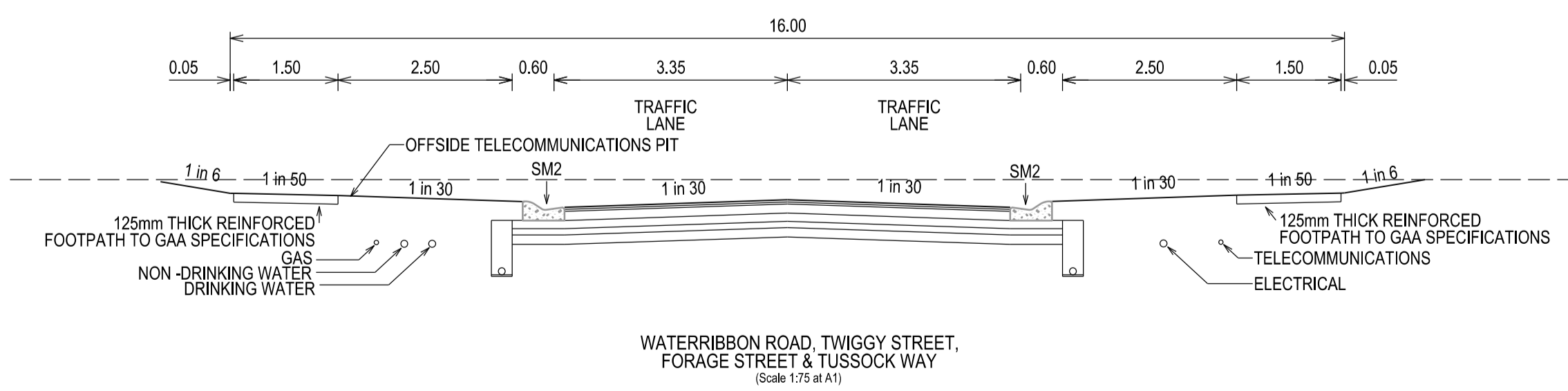
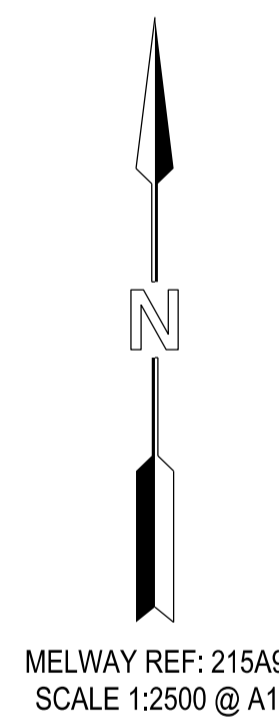

WATERBIBBON ROAD, TWIGGY STREET,
FORAGE STREET & TUSSOCK WAY
(Scale 1:75 @ A1)

SERVICE OFFSETS

Street	Gas	NDW	Water	Comms	Elec.	Lighting	Sewer
WATERBIBBON ROAD *	E 2.10	E 2.50	E 2.90	W 1.85	W 2.60	1.00 BOK	-
TWIGGY STREET *	N 2.10	N 2.50	N 2.90	S 1.85	S 2.60	1.00 BOK	-
FORAGE STREET *	N 2.10	N 2.50	N 2.90	S 1.85	S 2.60	1.00 BOK	N 1.00
TUSSOCK WAY *	N 2.10	N 2.50	N 2.90	S 1.85	S 2.60	1.00 BOK	-

SERVICE OFFSETS ARE MEASURED (m) FROM THE TITLE BOUNDARY UNLESS OTHERWISE SPECIFIED
* OFFSETS BASED ON DN63 GAS, DN100 NDW & DN100 WATER. SERVICES IN EXCESS OF THIS SIZING WILL RESULT IN OFFSIDE OPTIC FIBRE PITS TO BE LOCATED IN FOOTPATH.

VERSION DETAILS:

REV	DATE	DESCRIPTION	STATUS
A	04/06/2021	PRELIMINARY ISSUE	PRELIMINARY
B	21/06/2021	ADDITIONAL LOT ADDED. LOTS 520, 521, 522, 537 & 538 AMENDED.	PRELIMINARY
C	25/11/2021	KERB & ROAD X-SECT AMENDED. TURNING TEMPLATES ADDED. LOT 521 CROSSOVER SWAPPED.	PRELIMINARY

FILENAME: P:\1470\1470_5IE\2 - Design\6 - DGN\FLP01_SIS.dgn

DRAWN:	RC	DATE:	JUNE 2021	SCALE:	AS SHOWN
DESIGNED:	RC	DATE:	JUNE 2021	DATE PRINTED:	25/11/2021
AUTHORISED:	RB	DATE:	JUNE 2021		



SUITE 1, LEVEL 1, 84 MT ELIZA WAY, MT ELIZA VIC 3930
www.charltondegg.com.au

COUNCIL:
CARDINIA SHIRE COUNCIL

TITLE:
100 LECKY ROAD PTY LTD
BANYAN PLACE FLP STAGE 5
70-100 LECKY ROAD, OFFICER

LOCALITY PLAN, TYPICAL CROSS SECTIONS, SOT & SHEET INDEX

DRG NO. 1470_5_FLP/01	REV. C	SHEET 1 OF 4
--------------------------	-----------	--------------

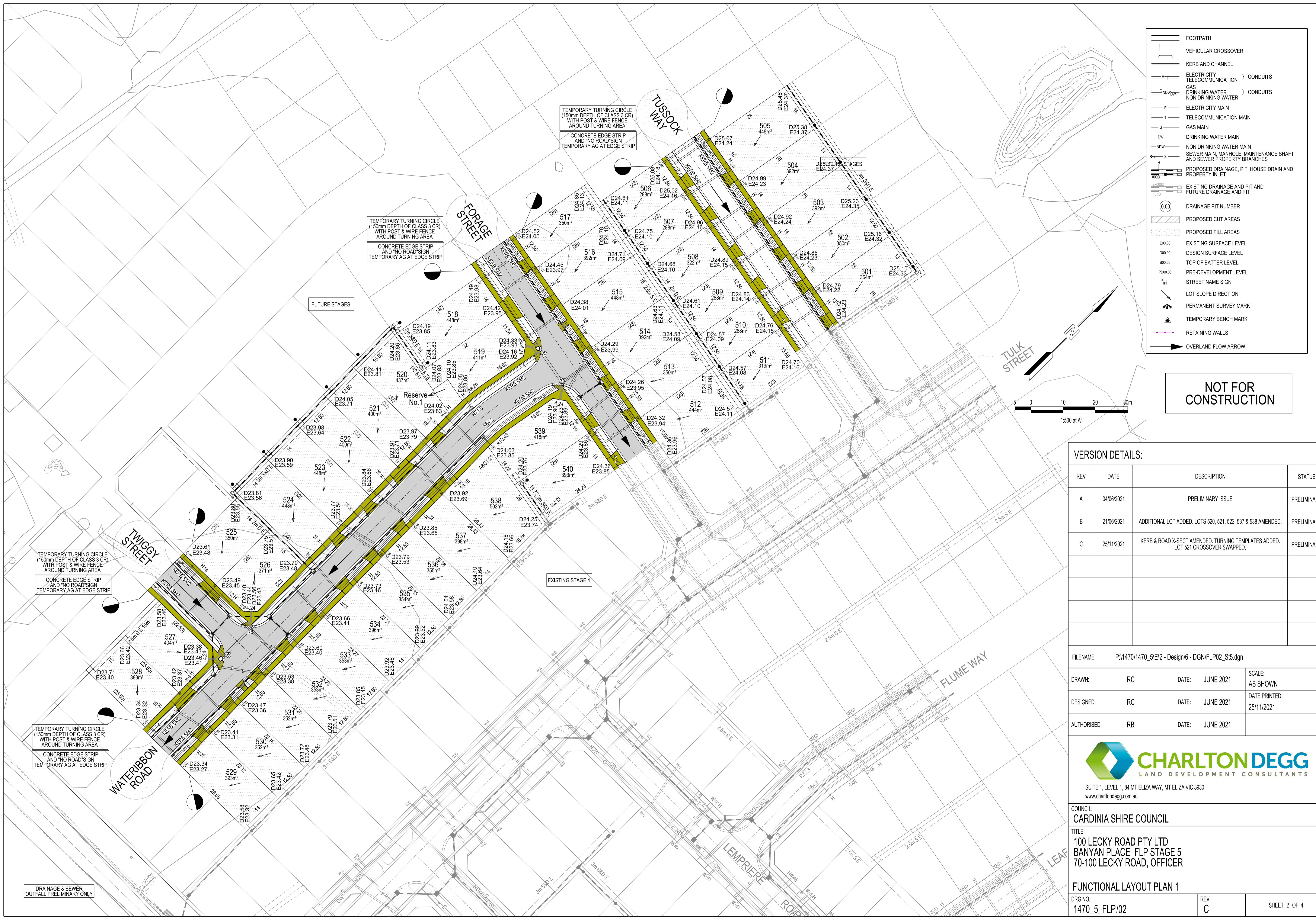

	FOOTPATH
	VEHICULAR CROSSOVER
	KERB AND CHANNEL
	ELECTRICITY TELECOMMUNICATION } CONDUITS
	GAS } CONDUITS
	DRINKING WATER } CONDUITS
	NON DRINKING WATER } CONDUITS
	ELECTRICITY MAIN
	TELECOMMUNICATION MAIN
	GAS MAIN
	DRINKING WATER MAIN
	NON DRINKING WATER MAIN
	SEWER MAIN, MANHOLE, MAINTENANCE SHAFT AND SEWER PROPERTY BRANCHES
	PROPOSED DRAINAGE, PIT, HOUSE DRAIN AND PROPERTY INLET
	EXISTING DRAINAGE AND PIT AND FUTURE DRAINAGE AND PIT
	DRAINAGE PIT NUMBER
	PROPOSED CUT AREAS
	PROPOSED FILL AREAS
	EXISTING SURFACE LEVEL
	DESIGN SURFACE LEVEL
	TOP OF BATTER LEVEL
	PRE-DEVELOPMENT LEVEL
	STREET NAME SIGN
	LOT SLOPE DIRECTION
	PERMANENT SURVEY MARK
	TEMPORARY BENCH MARK
	RETAINING WALLS
	OVERLAND FLOW ARROW

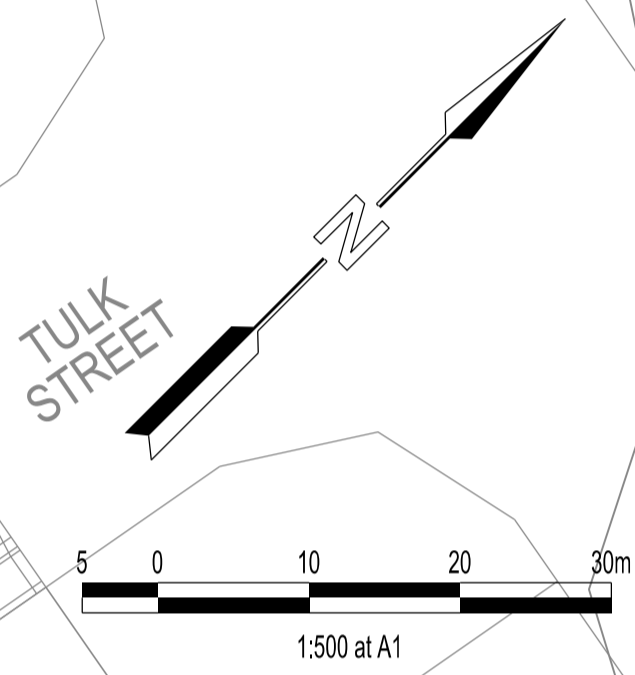

NOT FOR CONSTRUCTION

VERSION DETAILS:

REV	DATE	DESCRIPTION	STATUS
A	04/06/2021	PRELIMINARY ISSUE	PRELIMINARY
B	21/06/2021	ADDITIONAL LOT ADDED. LOTS 520, 521, 522, 537 & 538 AMENDED.	PRELIMINARY
C	25/11/2021	KERB & ROAD X-SECT AMENDED, TURNING TEMPLATES ADDED. LOT 521 CROSSOVER SWAPPED.	PRELIMINARY

FILENAME: P:\1470\1470_5IE2 - Design\6 - DGN\FLP02_S15.dgn

DRAWN:	RC	DATE:	JUNE 2021	SCALE:	AS SHOWN
DESIGNED:	RC	DATE:	JUNE 2021	DATE PRINTED:	25/11/2021
AUTHORISED:	RB	DATE:	JUNE 2021		



SUITE 1, LEVEL 1, 84 MT ELIZA WAY, MT ELIZA VIC 3930
www.charltondegg.com.au

COUNCIL: CARDINIA SHIRE COUNCIL

TITLE: 100 LECKY ROAD PTY LTD
BANYAN PLACE FLP STAGE 5
70-100 LECKY ROAD, OFFICER

FUNCTIONAL LAYOUT PLAN 1

DRG NO. 1470_5_FLP/02	REV. C	SHEET 2 OF 4
--------------------------	-----------	--------------

TEMPORARY TURNING CIRCLE (150mm DEPTH OF CLASS 3 CR) WITH POST & WIRE FENCE AROUND TURNING AREA
CONCRETE EDGE STRIP AND 'NO ROAD' SIGN
TEMPORARY AG AT EDGE STRIP

TEMPORARY TURNING CIRCLE (150mm DEPTH OF CLASS 3 CR) WITH POST & WIRE FENCE AROUND TURNING AREA
CONCRETE EDGE STRIP AND 'NO ROAD' SIGN
TEMPORARY AG AT EDGE STRIP

DRAINAGE & SEWER OUTFALL PRELIMINARY ONLY

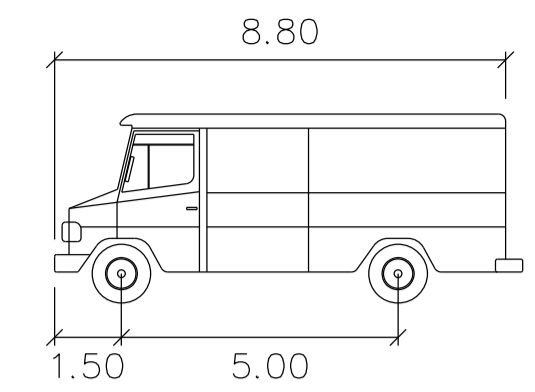
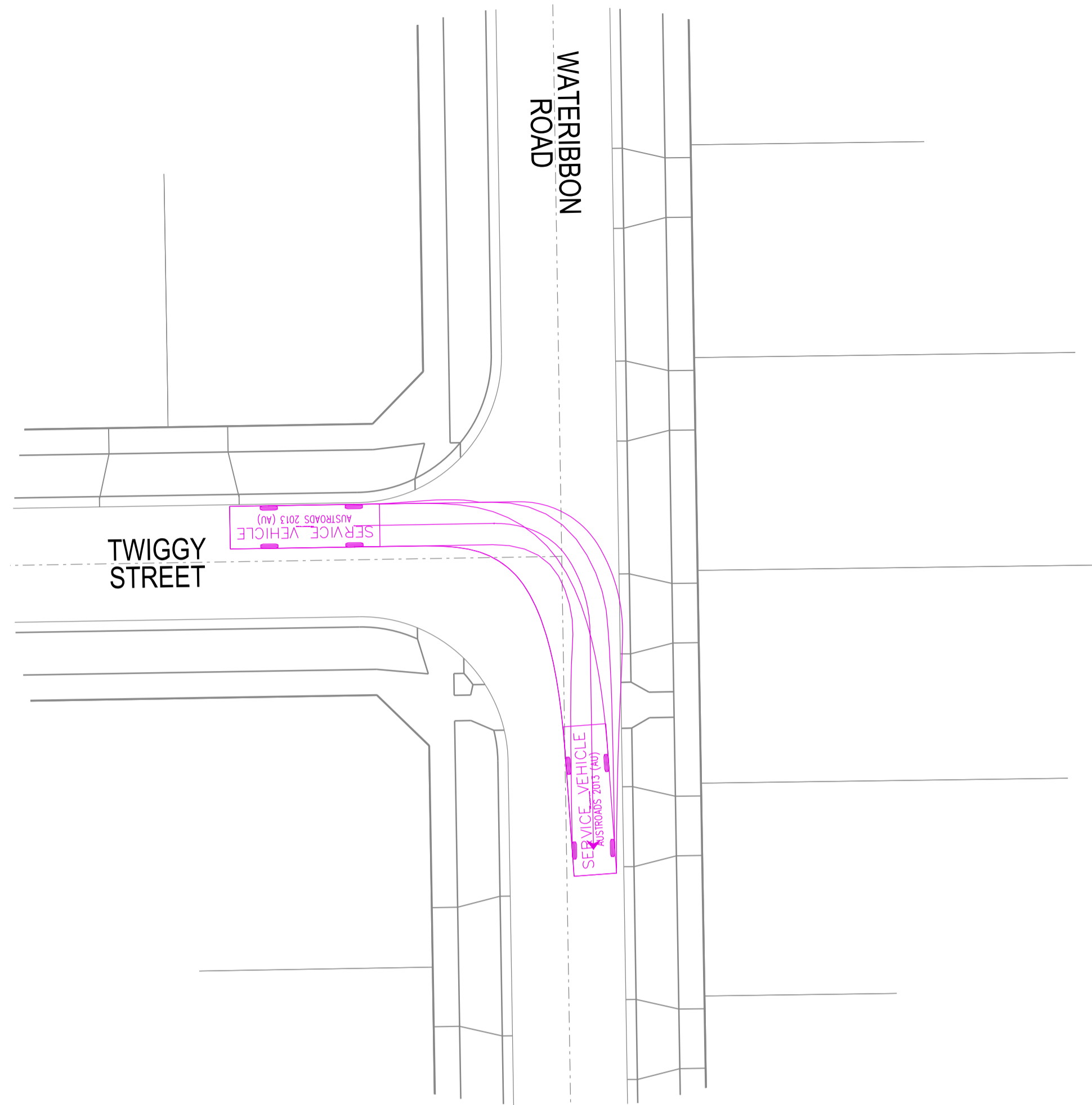
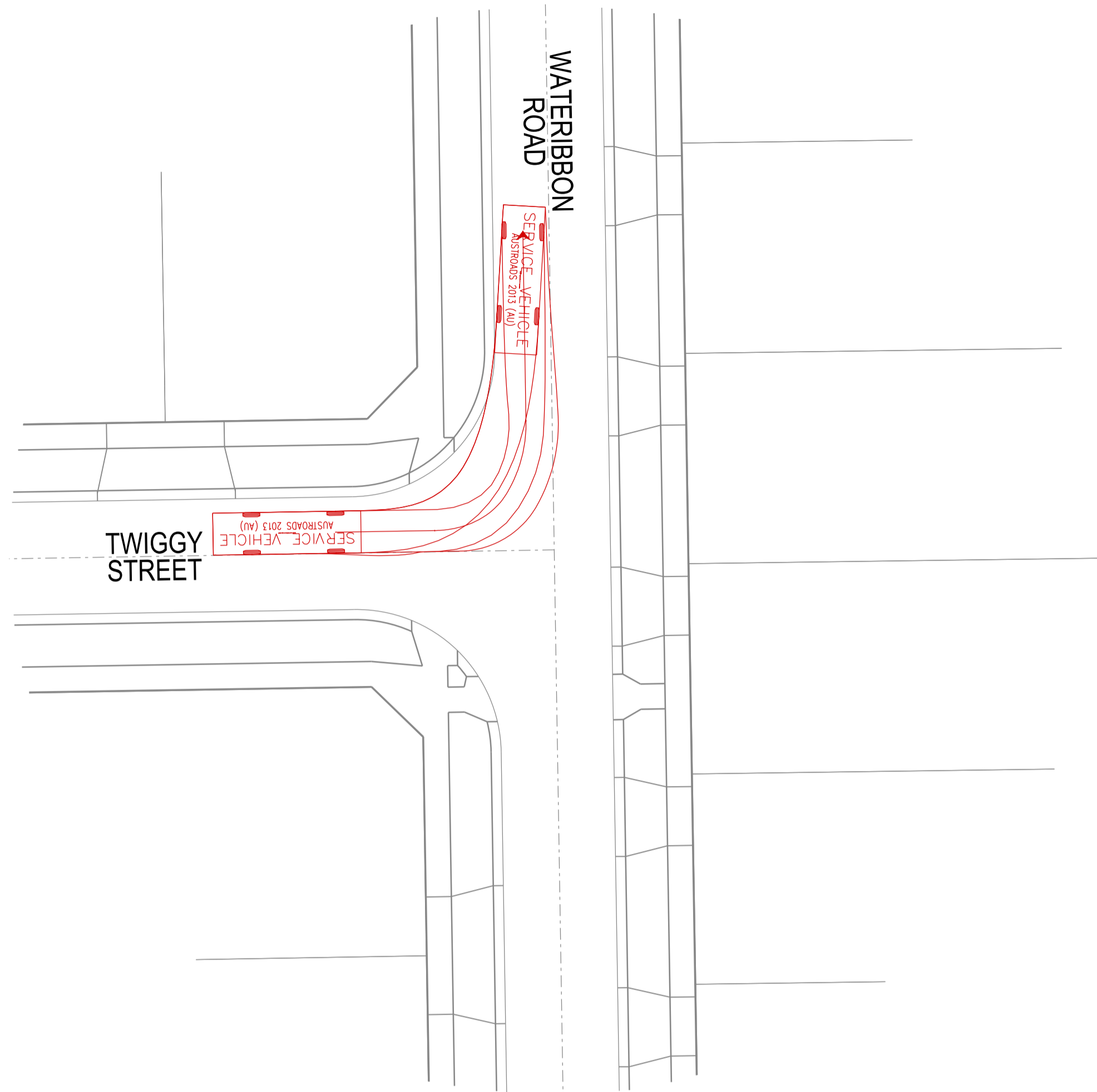

SERVICE VEHICLE

Width : 2.50 meters
 Track : 2.50
 Lock to Lock Time : 6.0
 Steering Angle : 38.7

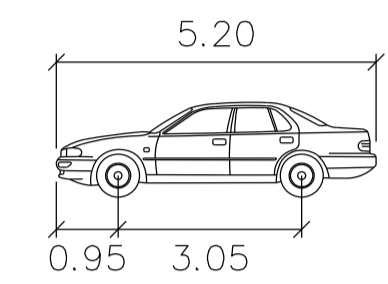

PASSENGER - CAR

Width : 1.94 meters
 Track : 1.84
 Lock to Lock Time : 6.0
 Steering Angle : 33.6

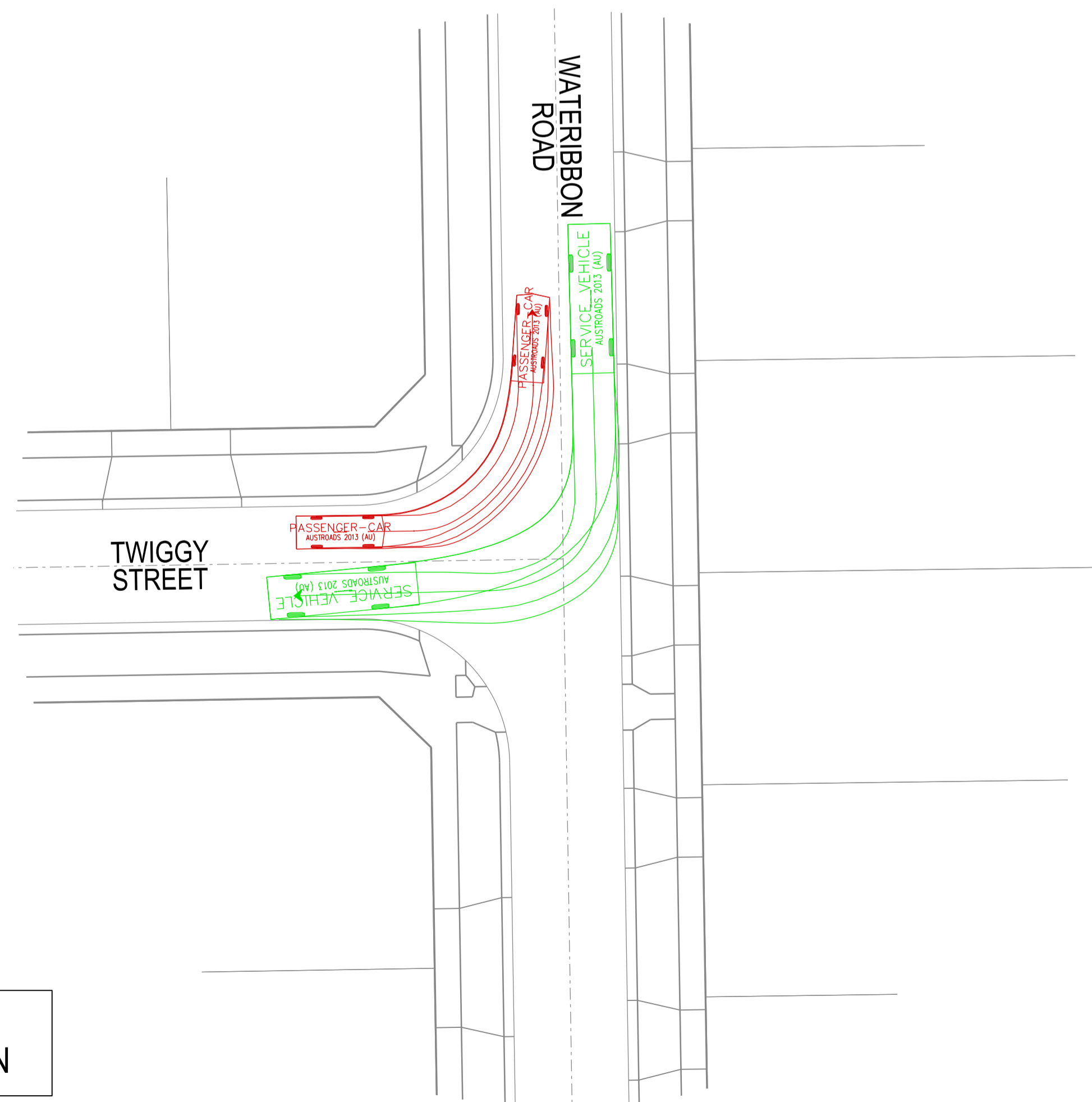
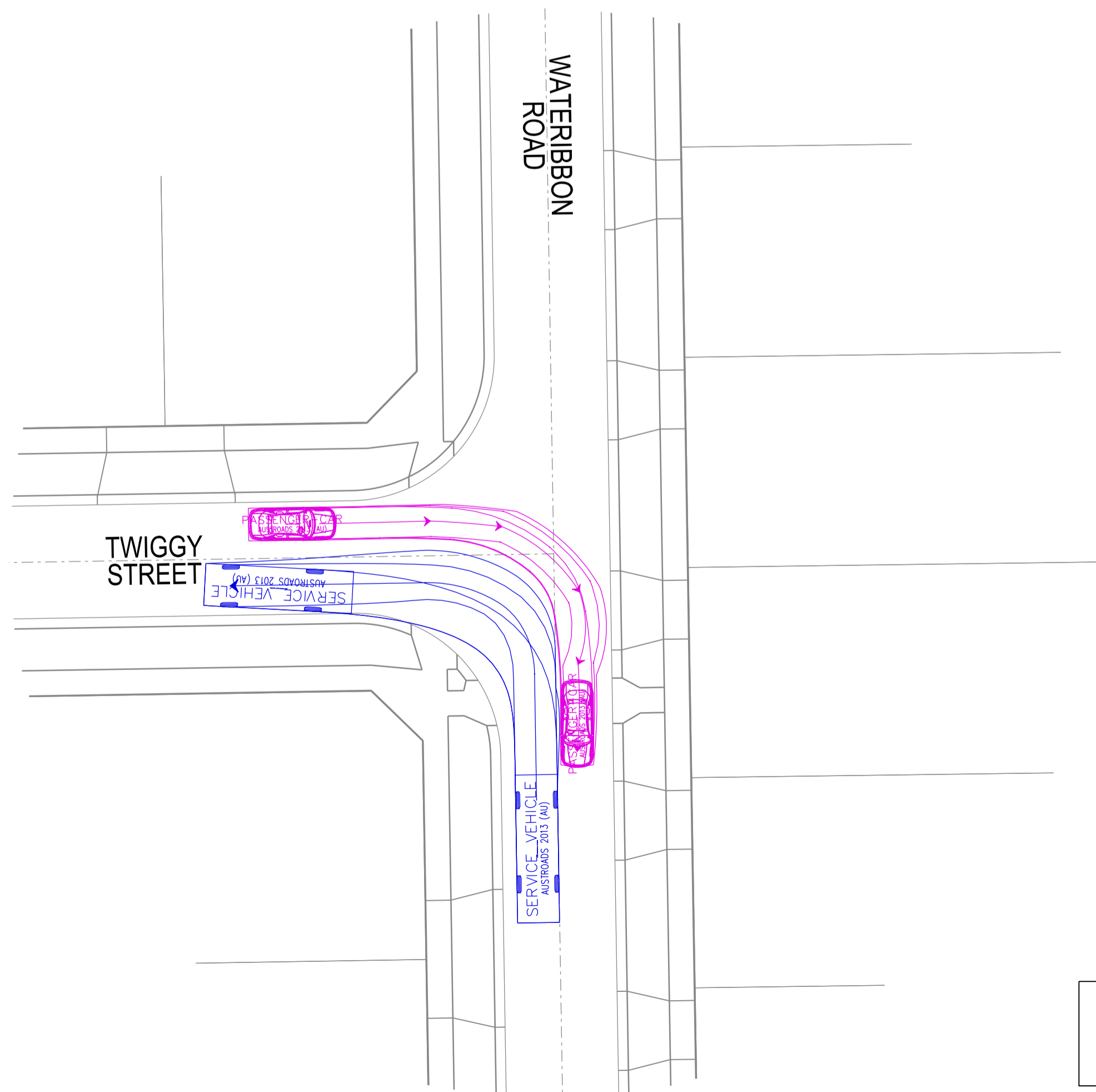

NOT FOR CONSTRUCTION

VERSION DETAILS:

REV	DATE	DESCRIPTION	STATUS
A	04/06/2021	PRELIMINARY ISSUE	PRELIMINARY
B	21/06/2021	ADDITIONAL LOT ADDED. LOTS 520, 521, 522, 537 & 538 AMENDED.	PRELIMINARY
C	25/11/2021	KERB & ROAD X-SECT AMENDED, TURNING TEMPLATES ADDED. LOT 521 CROSSOVER SWAPPED.	PRELIMINARY

FILENAME: P:\1470\1470_5IE\2 - Design\6 - DGN\FLP03_S15.dgn

DRAWN:	RC	DATE:	JUNE 2021	SCALE:	AS SHOWN
DESIGNED:	RC	DATE:	JUNE 2021	DATE PRINTED:	25/11/2021
AUTHORISED:	RB	DATE:	JUNE 2021		



COUNCIL: CARDINIA SHIRE COUNCIL		
TITLE: 100 LECKY ROAD PTY LTD BANYAN PLACE FLP STAGE 5 70-100 LECKY ROAD, OFFICER		
TURNING TEMPLATES		
DRG NO. 1470_5_FLP/03	REV. C	SHEET 3 OF 4

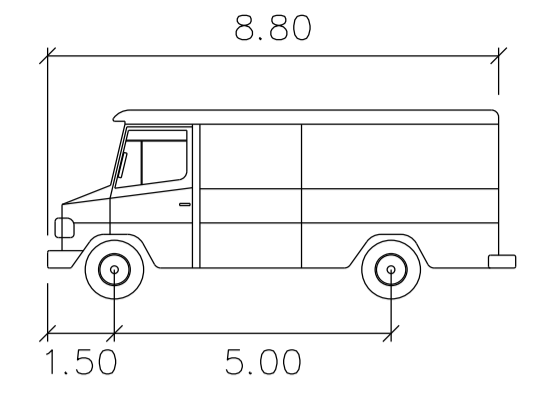

SERVICE VEHICLE

Width : 2.50 meters
 Track : 2.50
 Lock to Lock Time : 6.0
 Steering Angle : 38.7

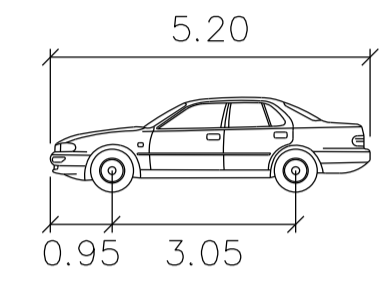

PASSENGER-CAR

Width : 1.94 meters
 Track : 1.84
 Lock to Lock Time : 6.0
 Steering Angle : 33.6

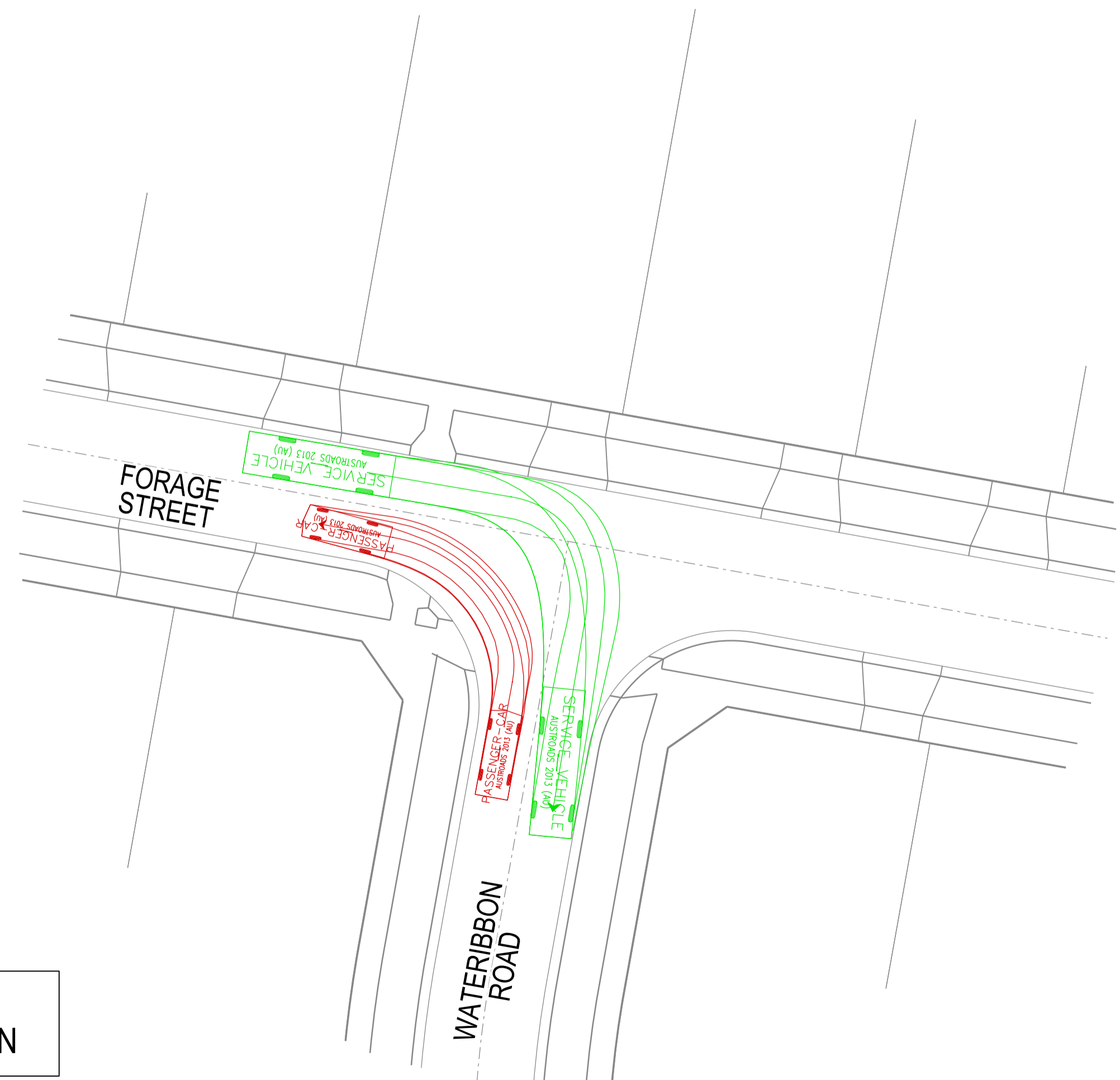
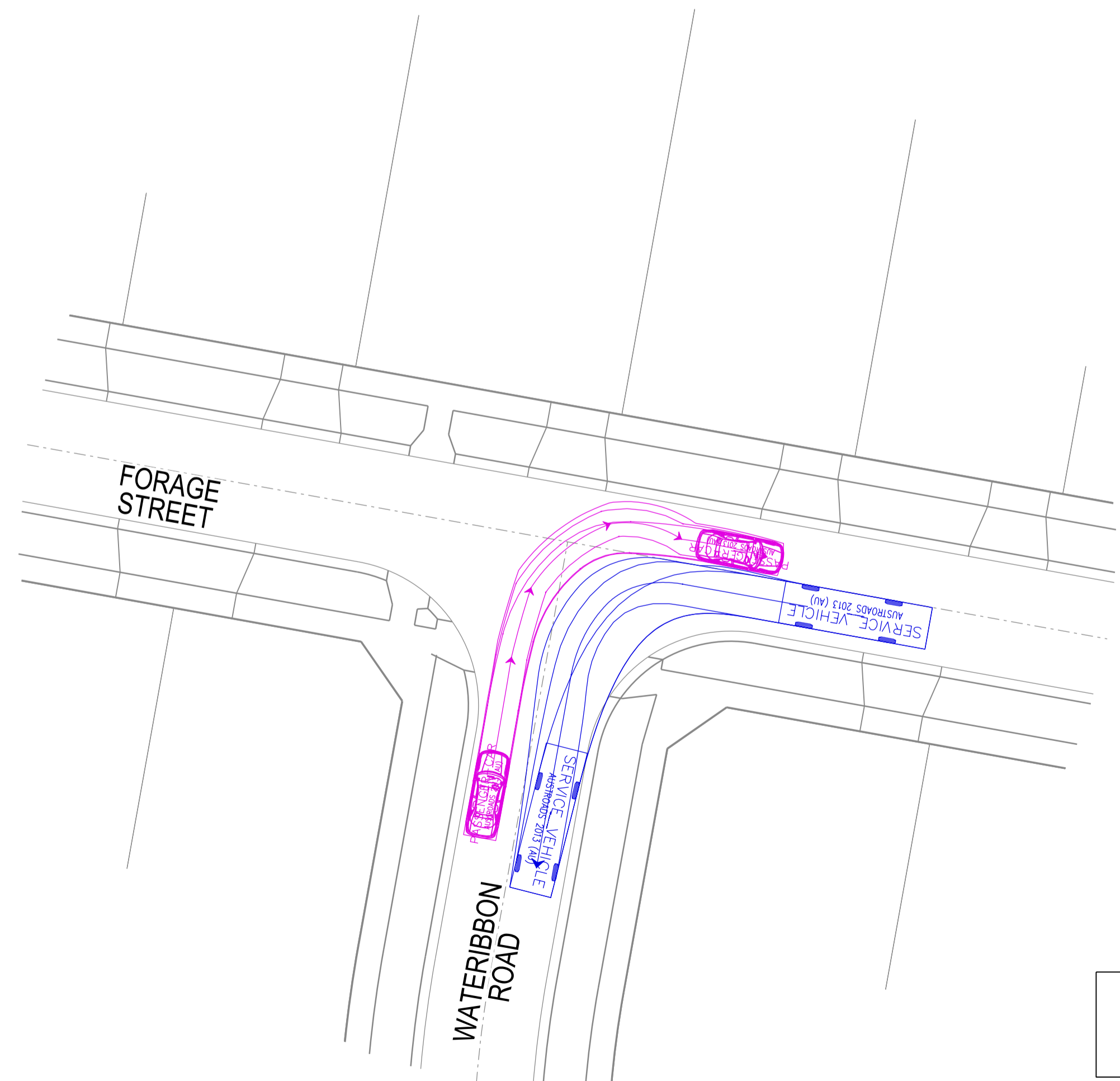
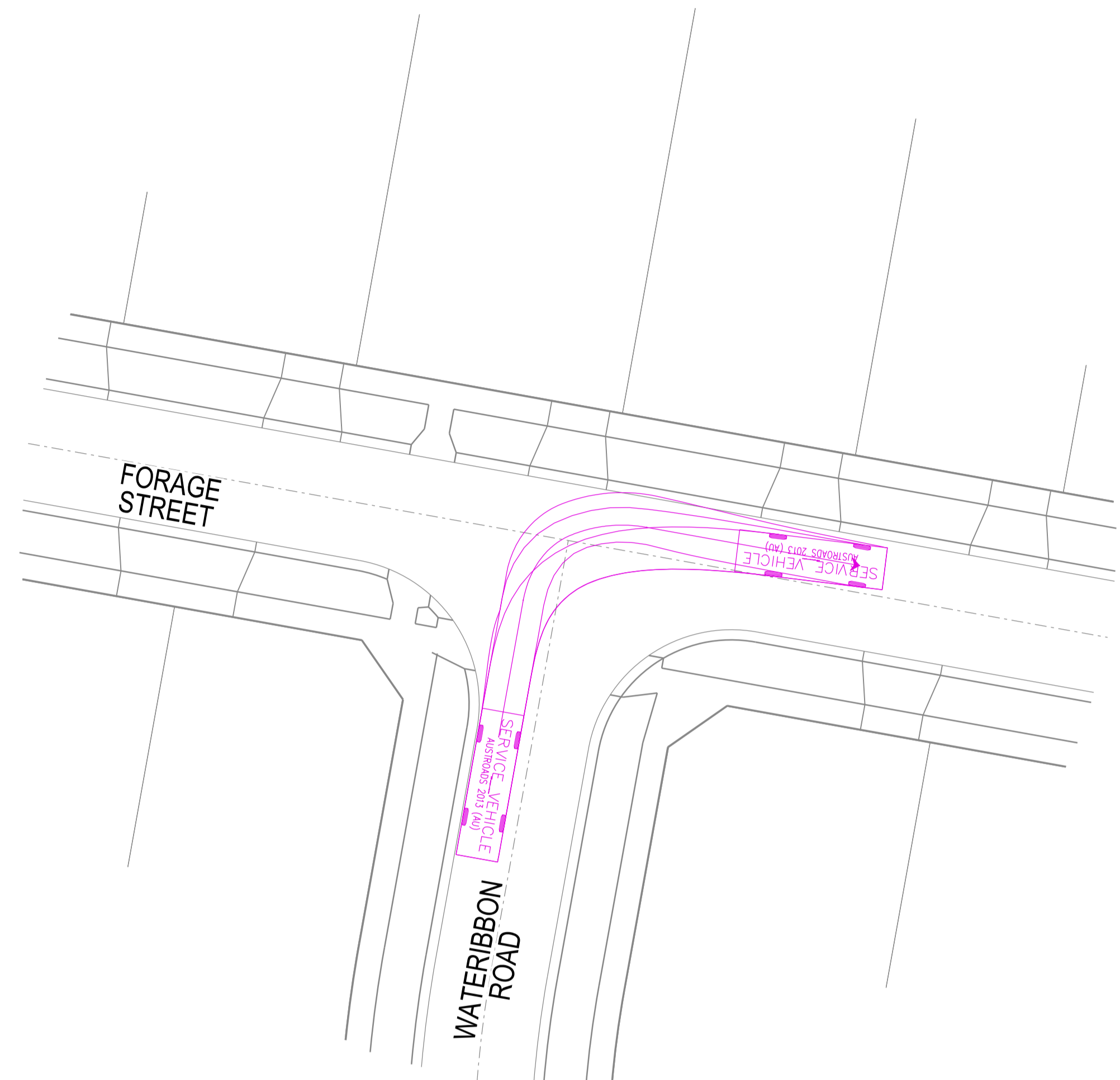
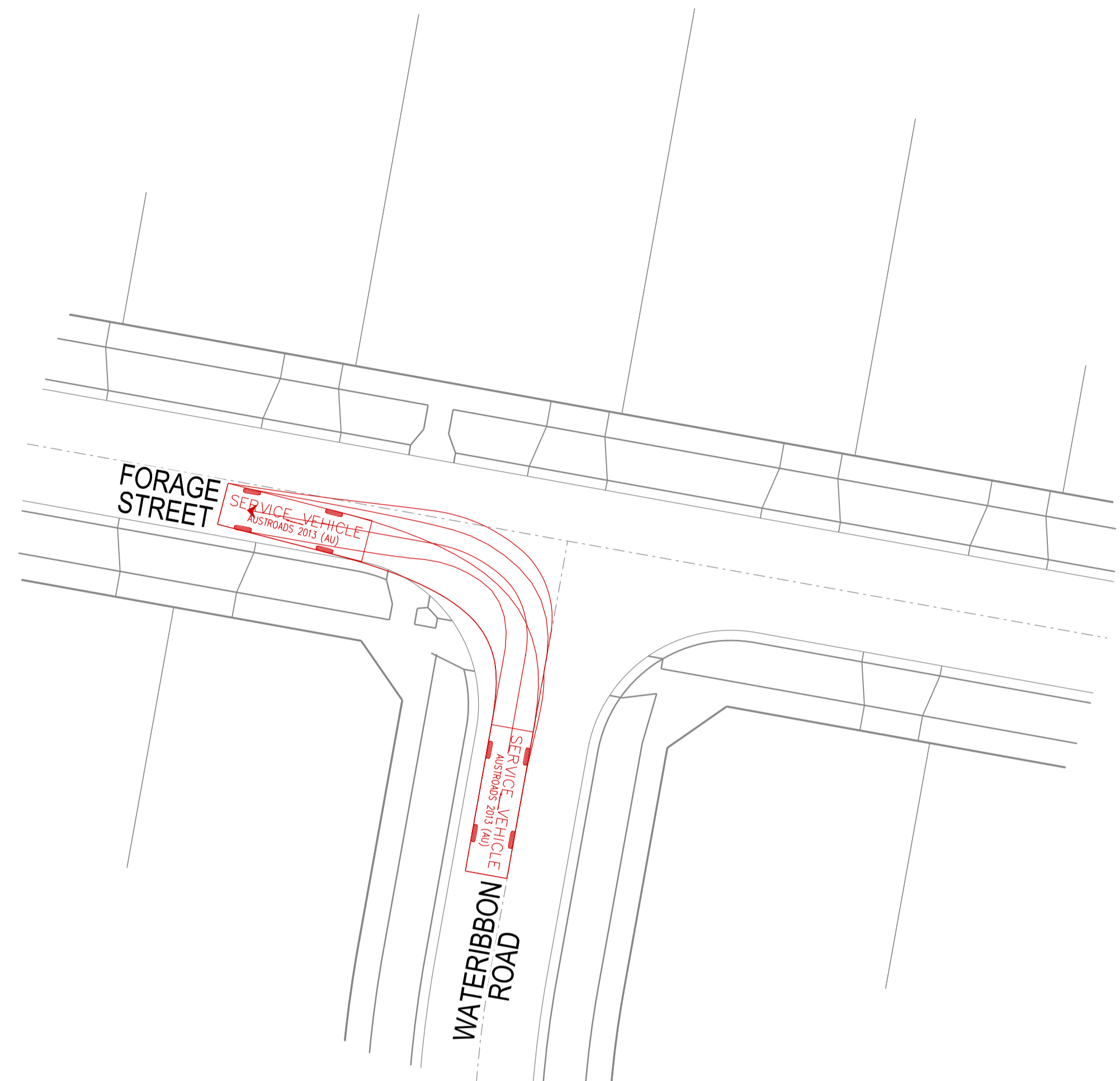

NOT FOR CONSTRUCTION

VERSION DETAILS:

REV	DATE	DESCRIPTION	STATUS
A	04/06/2021	PRELIMINARY ISSUE	PRELIMINARY
B	21/06/2021	ADDITIONAL LOT ADDED. LOTS 520, 521, 522, 537 & 538 AMENDED.	PRELIMINARY
C	25/11/2021	KERB & ROAD X-SECT AMENDED. TURNING TEMPLATES ADDED. LOT 521 CROSSOVER SWAPPED.	PRELIMINARY

FILENAME: P:\1470\1470_5\1E\2 - Design\6 - DGN\FLP04_S15.dgn

DRAWN:	RC	DATE:	JUNE 2021	SCALE:	AS SHOWN
DESIGNED:	RC	DATE:	JUNE 2021	DATE PRINTED:	25/11/2021
AUTHORISED:	RB	DATE:	JUNE 2021		



SUITE 1, LEVEL 1, 84 MT ELIZA WAY, MT ELIZA VIC 3830
 www.charltondegg.com.au

COUNCIL: CARDINIA SHIRE COUNCIL
 TITLE: 100 LECKY ROAD PTY LTD
 BANYAN PLACE FLP STAGE 5
 70-100 LECKY ROAD, OFFICER

DRG NO. 1470_5_FLP/04	REV. C	SHEET 3 OF 4
--------------------------	-----------	--------------