

100 LECKY ROAD PTY LTD 70-100 LECKY ROAD FLP STAGE 2 70-100 LECKY ROAD, OFFICER CARDINIA SHIRE COUNCIL

SHEET INDEX

1. LOCALITY PLAN, TYPICAL CROSS SECTIONS, SOT & SHEET INDEX
2. DETAIL PLAN 1
3. TURNING TEMPLATES

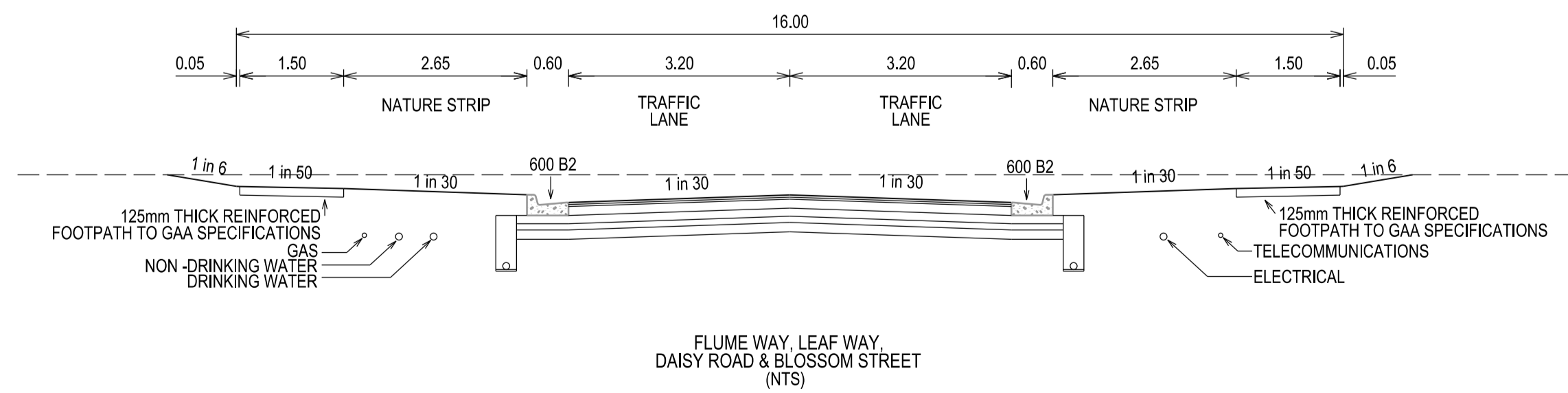
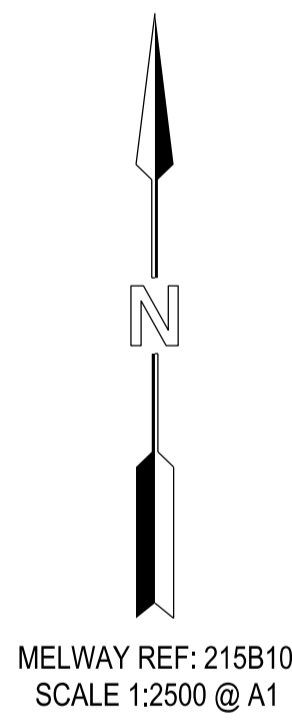

SERVICE OFFSETS

Street	Gas	NDW	Water	Comms	Elec.	Lighting	Sewer
FLUME WAY	W 2.00	W 2.50	W 3.00	E 1.85	E 2.60	1.00 BOK	W -
DAISY ROAD	S 2.00	S 2.50	S 3.00	N 1.85	N 2.60	1.00 BOK	W -
LEAF WAY	W 2.00	W 2.50	W 3.00	E 1.85	E 2.60	1.00 BOK	W -
BLOSSOM STREET	N 2.00	N 2.50	N 3.00	S 1.85	S 2.60	1.00 BOK	N -

SERVICE OFFSETS ARE MEASURED (m) FROM THE TITLE BOUNDARY UNLESS OTHERWISE SPECIFIED

VERSION DETAILS:

REV	DATE	DESCRIPTION	STATUS
-	3/11/20	-	PRELIMINARY
A	20/11/20	PRELIMINARY LOT LEVELS ADDED	PRELIMINARY
B	17/05/21	ROAD CROSS SECTIONS AMENDED	PRELIMINARY

FILENAME: P:\1470\1470_21E\2 - Design\6 - DGN\FLP01_S\2.dgn

DRAWN:	RC	DATE:	MAY 2021	SCALE:	AS SHOWN
DESIGNED:	RC	DATE:	MAY 2021	DATE PRINTED:	17/05/2021
AUTHORISED:	RB	DATE:	MAY 2021		



SUITE 1, LEVEL 1, 84 MT ELIZA WAY, MT ELIZA VIC 3930
www.charltondegg.com.au

COUNCIL:
CARDINIA SHIRE COUNCIL

TITLE:
100 LECKY ROAD PTY LTD
70-100 LECKY ROAD FLP STAGE 2
70-100 LECKY ROAD, OFFICER

LOCALITY PLAN, CROSS SECTION, SOT AND SHEET INDEX

DRG NO. 1470_2_FLP/01	REV. B	SHEET 1 OF 3
--------------------------	-----------	--------------

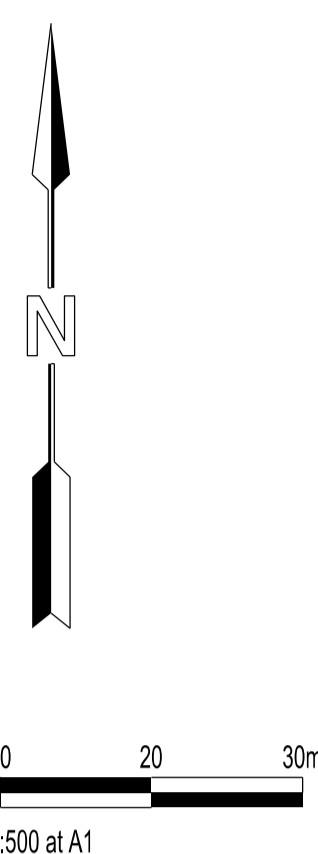
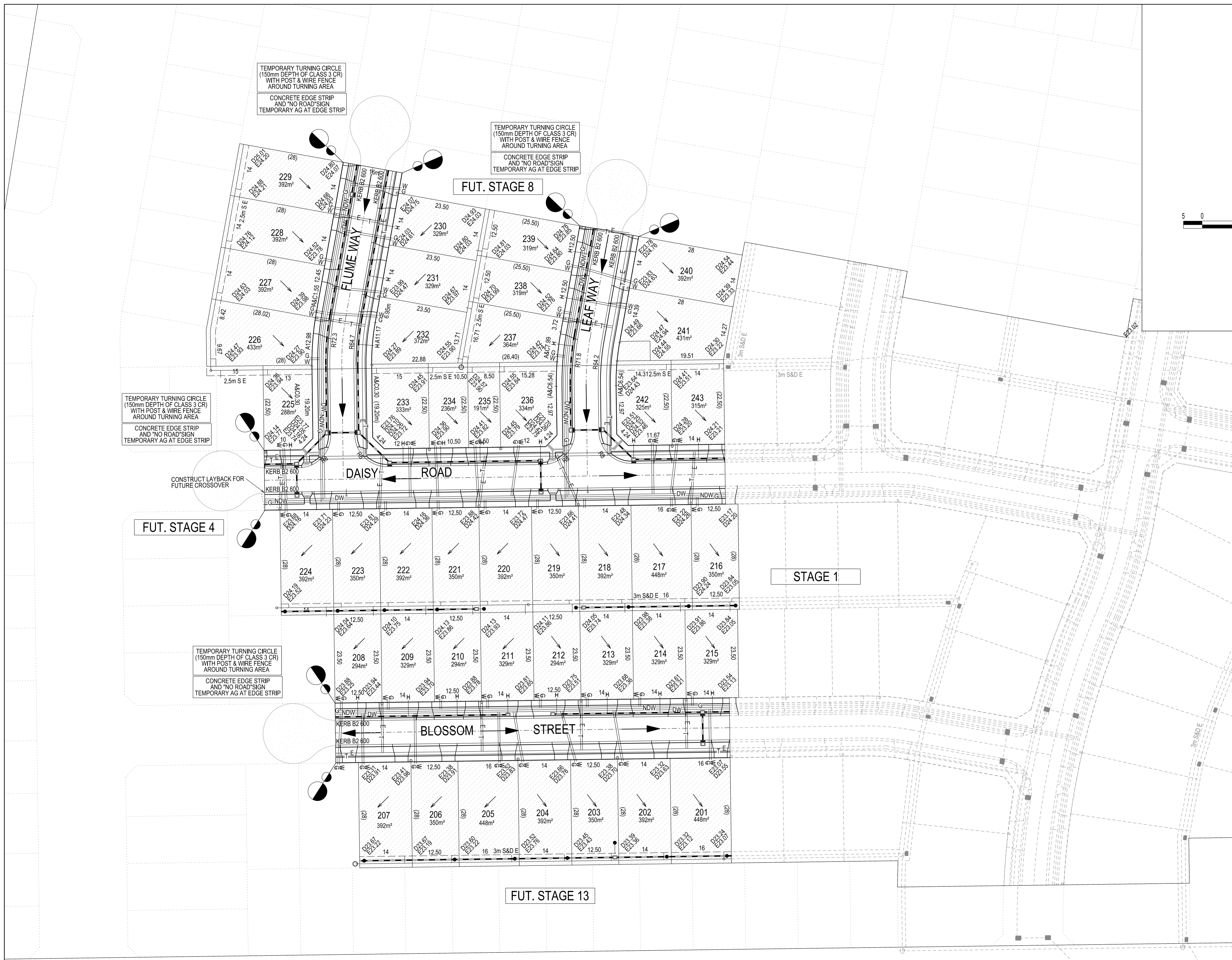

- FOOTPATH
- KERB AND CHANNEL
- ELECTRICITY TELECOMMUNICATION } CONDUITS
- GAS DRINKING WATER NON DRINKING WATER } CONDUITS
- ELECTRICITY MAIN
- GAS MAIN
- DRINKING WATER MAIN
- NON DRINKING WATER MAIN
- SEWER MAIN, MANHOLE, MAINTENANCE SHAFT AND SEWER PROPERTY BRANCHES
- PROPOSED DRAINAGE, PIT, HOUSE DRAIN AND PROPERTY INLET
- EXISTING DRAINAGE AND PIT AND FUTURE DRAINAGE AND PIT
- (0.00) DRAINAGE PIT NUMBER
- PROPOSED CUT AREAS
- PROPOSED FILL AREAS
- E00.00 EXISTING SURFACE LEVEL
- D00.00 DESIGN SURFACE LEVEL
- B00.00 TOP OF BATTER LEVEL
- P000.00 PRE-DEVELOPMENT LEVEL
- STREET NAME SIGN
- LOT SLOPE DIRECTION
- PERMANENT SURVEY MARK
- TEMPORARY BENCH MARK
- RETAINING WALLS
- OVERLAND FLOW ARROW

DRAINAGE & SEWER
OUTFALL PRELIMINARY ONLY

VERSION DETAILS:

REV	DATE	DESCRIPTION	STATUS
-	3/11/20	-	PRELIMINARY
A	20/11/20	PRELIMINARY LOT LEVELS ADDED	PRELIMINARY
B	17/05/21	ROAD CROSS SECTIONS AMENDED	PRELIMINARY

FILENAME: P:\1470\1470_21E2 - Design\6 - DGN\FLP02_S12.dgn

DRAWN:	RC	DATE:	MAY 2021	SCALE:	AS SHOWN
DESIGNED:	RC	DATE:	MAY 2021	DATE PRINTED:	17/05/2021
AUTHORISED:	RB	DATE:	MAY 2021		



SUITE 1, LEVEL 1, 84 MT ELIZA WAY, MT ELIZA VIC 3930
www.charltondegg.com.au

COUNCIL:
CARDINIA SHIRE COUNCIL

TITLE:
100 LECKY ROAD PTY LTD
70-100 LECKY ROAD FLP STAGE 2
70-100 LECKY ROAD, OFFICER

FUNCTIONAL LAYOUT PLAN 1

DRG NO. 1470_2_FLP/02	REV. B	SHEET 2 OF 3
--------------------------	-----------	--------------

PRELIMINARY

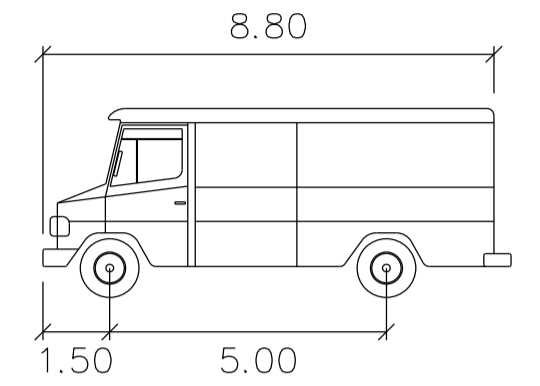
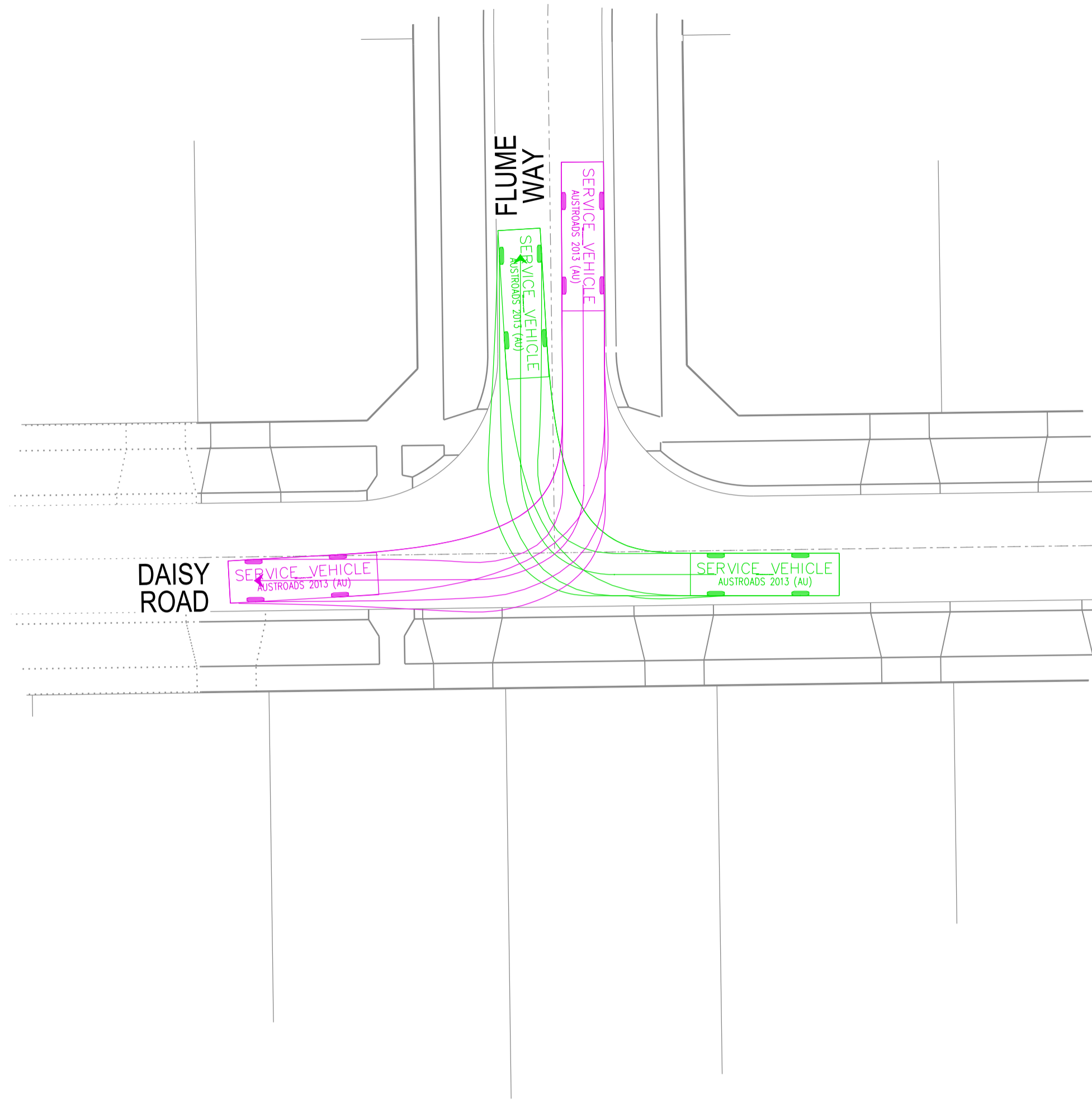
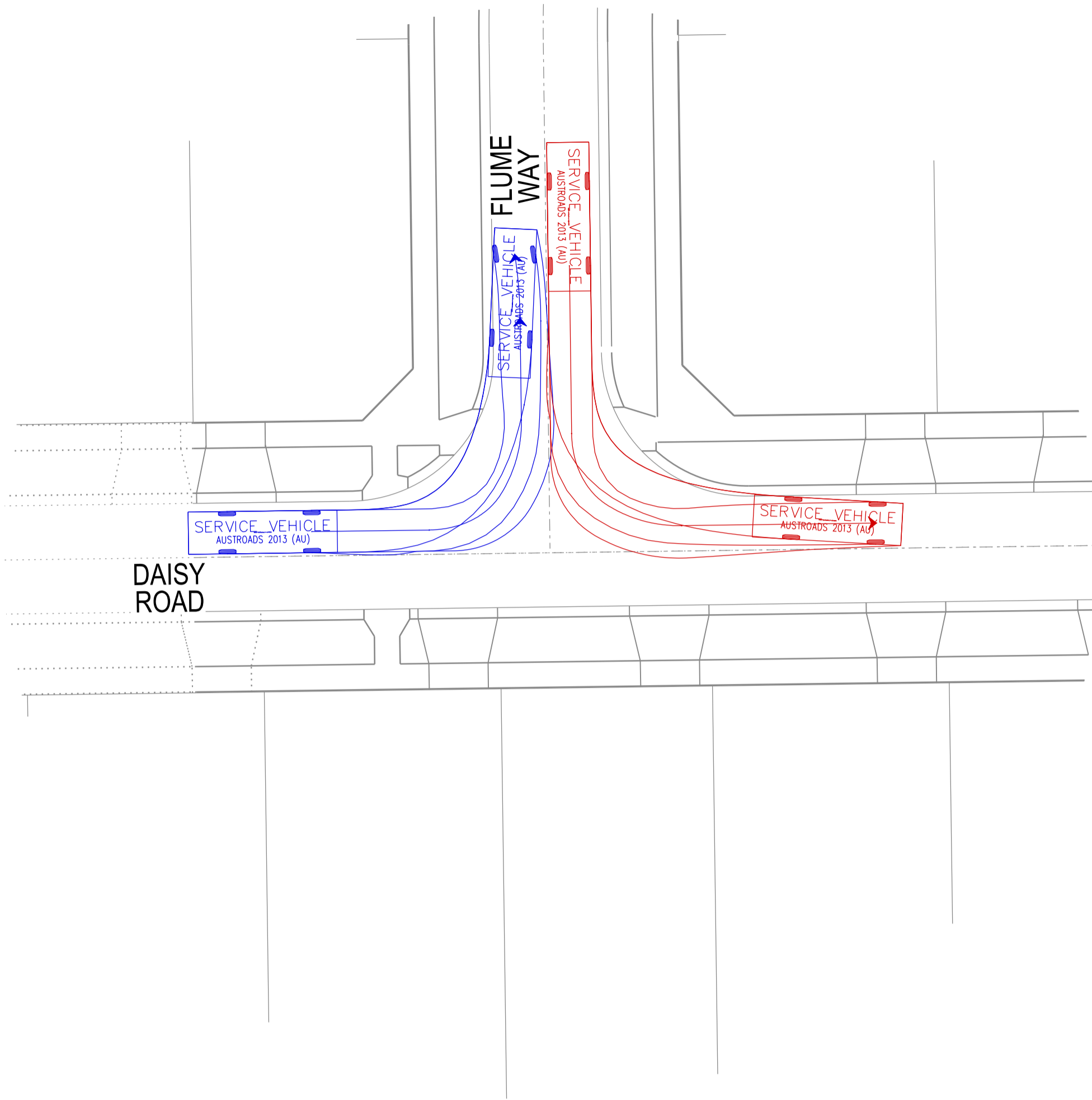

SERVICE VEHICLE

Width : 2.50 meters
 Track : 2.50
 Lock to Lock Time : 6.0
 Steering Angle : 38.7

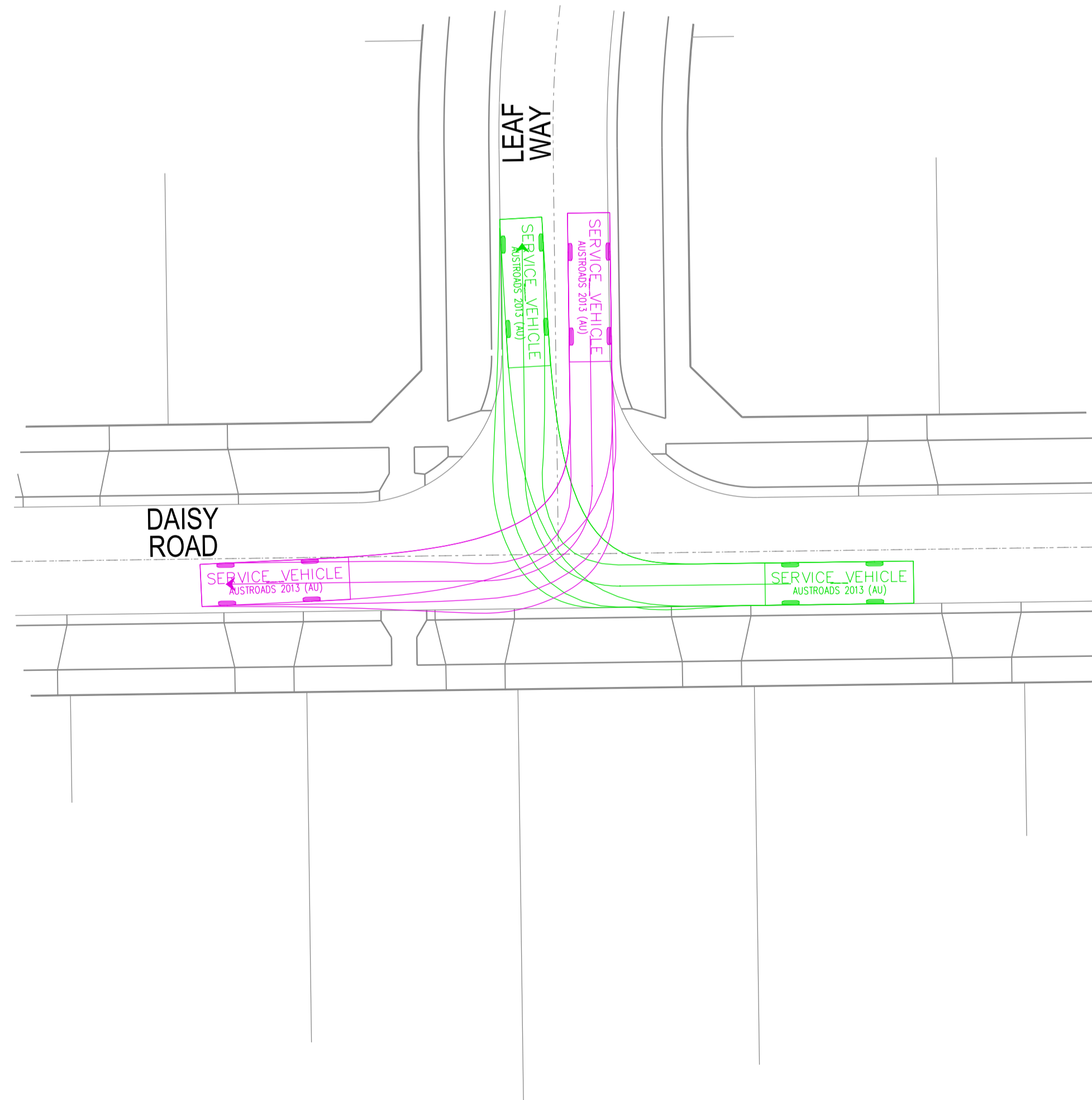
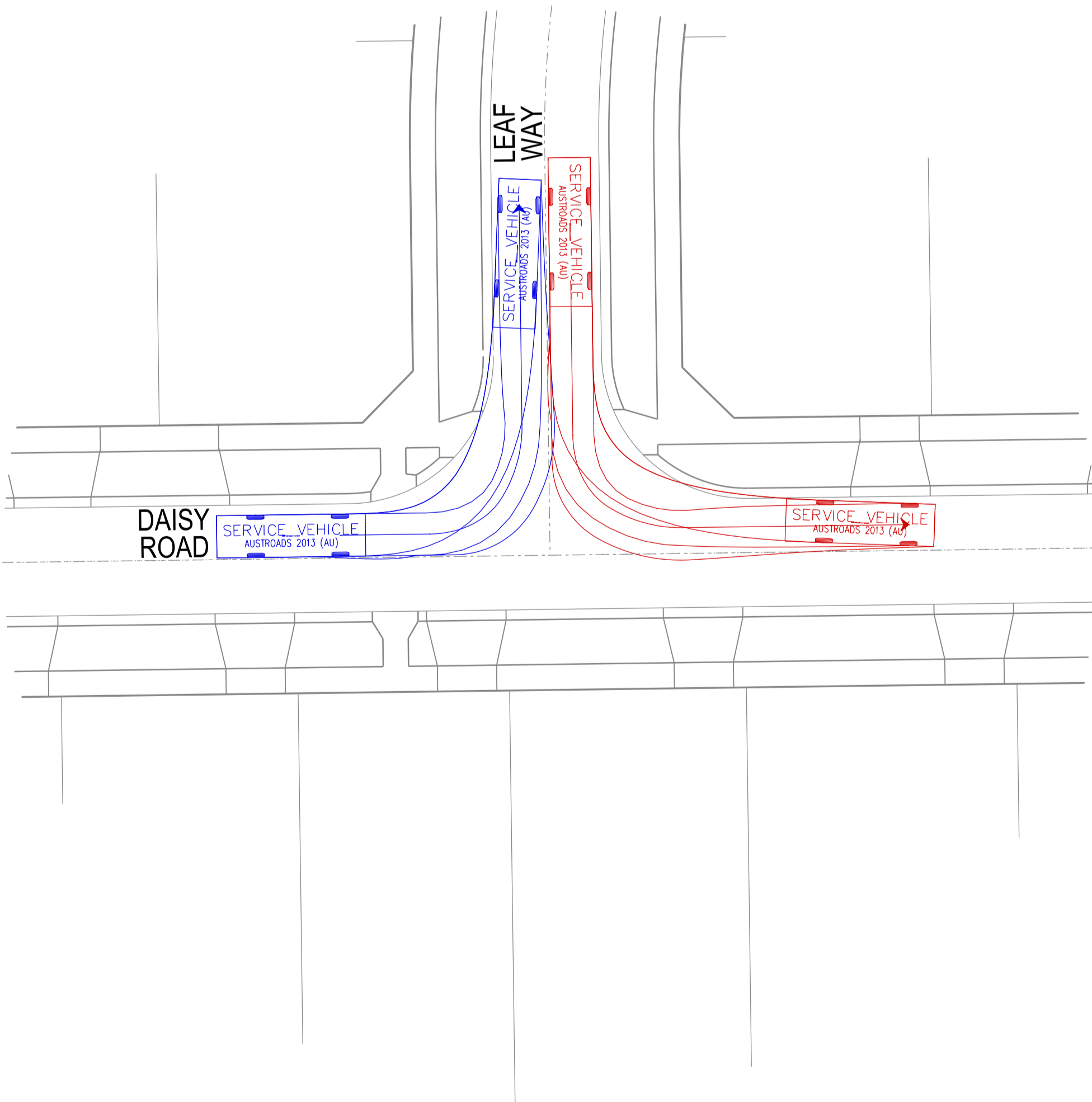

VERSION DETAILS:

REV	DATE	DESCRIPTION	STATUS
-	3/11/20	-	PRELIMINARY
A	20/11/20	PRELIMINARY LOT LEVELS ADDED	PRELIMINARY
B	17/05/21	ROAD CROSS SECTIONS AMENDED	PRELIMINARY

FILENAME: P:\1470\1470_21E\2 - Design\6 - DGN\FLP03_S12.dgn

DRAWN:	RC	DATE:	MAY 2021	SCALE:	AS SHOWN
DESIGNED:	RC	DATE:	MAY 2021	DATE PRINTED:	17/05/2021
AUTHORISED:	RB	DATE:	MAY 2021		



COUNCIL:
CARDINIA SHIRE COUNCIL

TITLE:
100 LECKY ROAD PTY LTD
70-100 LECKY ROAD FLP STAGE 2
70-100 LECKY ROAD, OFFICER

TURNING TEMPLATES

DRG NO. 1470_2_FLP/03	REV. B	SHEET 3 OF 3
--------------------------	-----------	--------------